

# FPR 2-1617 1623 2614 FPR 4-3316

Precision Shunt Resistors

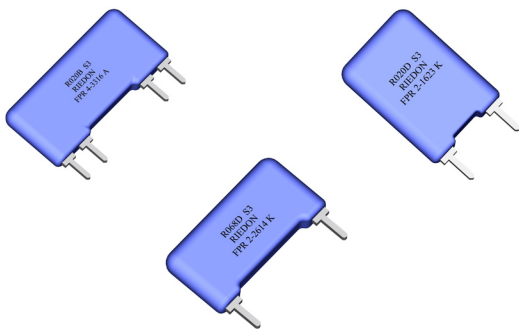

- Resistances from 0.001Ohm to 100Ohms
- Power Rating to 2Watt
- Resistance Tolerances to  $\pm 0.1\%$
- TCR to  $\pm 15\text{ppm/K}$
- Load Stability to 0.1%

## SPECIFICATIONS

Type	FPR 2-1617	FPR 2-1623	FPR 2-2614	FPR 4-3316
Resistance Range	0.01 to 50 Ohms	0.01 to 100 Ohms		0.001 to 100 Ohms
Power rating (70°C)	1 W	2 W		
Tolerances from 0.001 Ohms from 0.005 Ohms from 0.01 Ohms from 0.02 Ohms from 1.0 Ohms	0.5% / 1% / 2% / 5% 0.25% / 0.5% / 1% / 2% / 5% 0.1% / 0.25% / 0.5% / 1% / 2% / 5%			1% / 2% 0.5% / 1% / 2% 0.25% / 0.5% / 1% 0.1% / 0.25% / 0.5%
Stability	0.1% / 0.2% / 0.5% (depends on stress)			
Temperature Coefficient	R > 0.2 Ohms $\pm 15\text{ppm/K}$ (20 to 60°C) R $\leq$ 0.2 Ohms TCR see table A next page			$\pm 15\text{ppm/K}$ (20 to 60°C)
Insulation Resistance	> 10 GOhm			
Thermal EMF	< 0.1 $\mu\text{V/K}$			
Operating Temperature Range	-40 to 130°C			
Resistor Material	CuNiMn-Foil			
Substrate	anodized aluminium			
Housing	Epoxy sintered			
Connector Material	Cu tinned			
Terminals	2			4

## Ordering Information

Part Number - Resistance - Contact - Tolerance  
FPR 4-3316 0.01 Ohms A 1.0%

Official Rep: Microhm Electronics Ltd ☎ 86-755-8271 9930 📠 86-755-8271 9926 Email:sales@microhm.com

官方代理：万利隆电子有限公司

[www.microhm.com](http://www.microhm.com)

## SPECIFICATIONS (continued)

### Temperature Coefficient

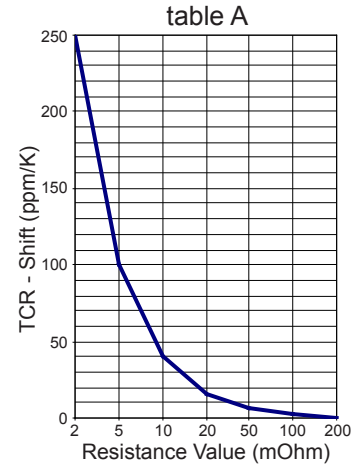
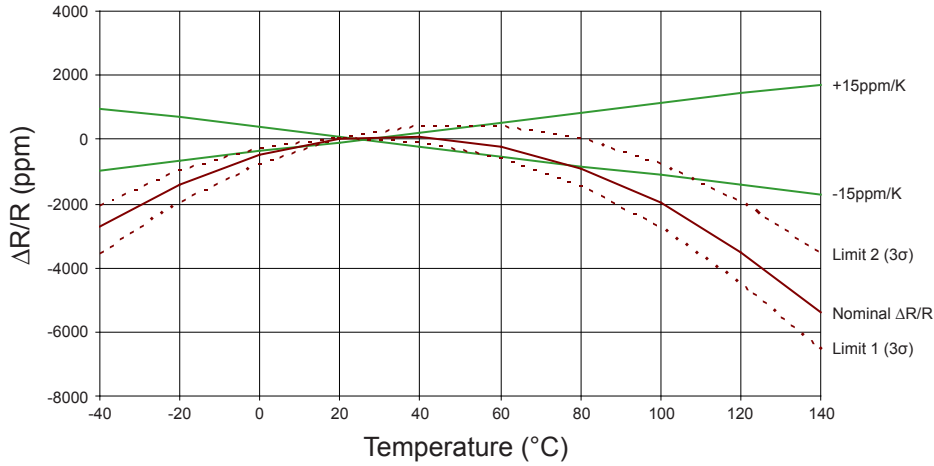

### Derating

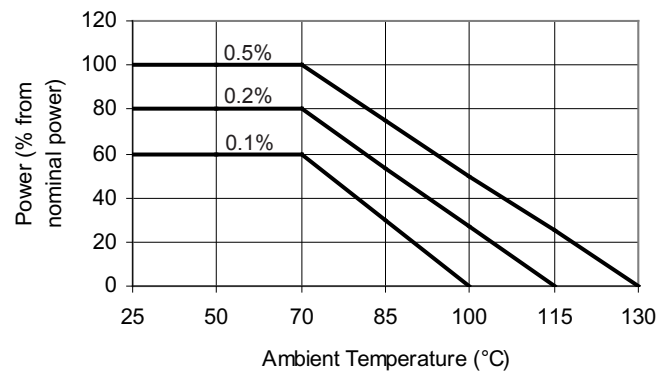

### Dimensions

#### FPR 2-1617

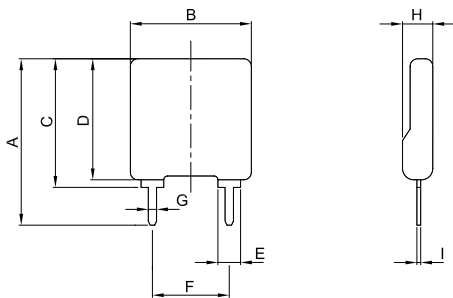

Dimension	mm	tol. (±mm)	inches	tol. (±inches)
A	22.00	0.2	0.87	0.008
B	16.00	0.2	0.63	0.008
C	17.00	0.2	0.67	0.008
D	16.00	0.2	0.63	0.008
E	3.00	0.1	0.12	0.004
F	10.16	0.2	0.40	0.008
G(A-Contact)	1.50	0.1	0.06	0.004
G(K-Contact)	1.10	0.1	0.04	0.004
H	4.30	0.2	0.17	0.008
I (A-Contact)	0.80	0.1	0.03	0.004
I (K-Contact)	0.50	0.1	0.02	0.004

**SPECIFICATIONS** (continued)

FPR 2-1623

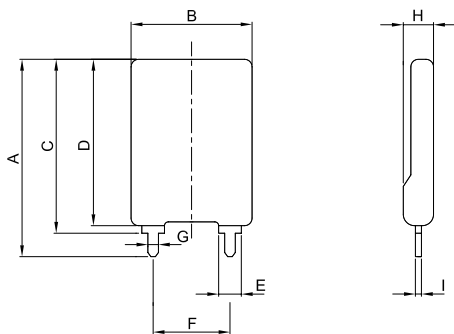

Dimension	mm	tol. (±mm)	inches	tol. (±inches)
A	26.10	0.2	1.03	0.008
B	16.00	0.2	0.63	0.008
C	23.00	0.2	0.91	0.008
D	22.00	0.2	0.87	0.008
E	3.00	0.1	0.12	0.004
F	10.16	0.2	0.40	0.008
G(B-Contact)	1.40	0.1	0.06	0.004
H	4.30	0.2	0.17	0.008
I (B-Contact)	0.80	0.1	0.03	0.004

FPR 2-2614

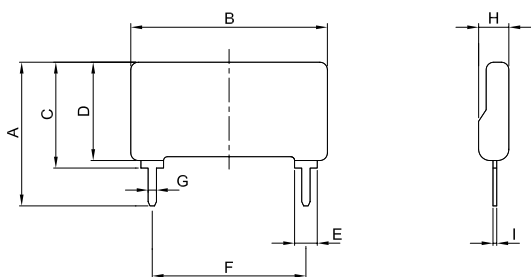

Dimension	mm	tol. (±mm)	inches	tol. (±inches)
A	19.00	0.2	0.75	0.008
B	26.00	0.2	1.02	0.008
C	14.00	0.2	0.55	0.008
D	13.00	0.2	0.51	0.008
E	3.00	0.1	0.12	0.004
F	20.32	0.2	0.80	0.008
G(A-Contact)	1.50	0.1	0.06	0.004
G(K-Contact)	1.10	0.1	0.04	0.004
H	4.30	0.2	0.17	0.008
I (A-Contact)	0.80	0.1	0.03	0.004
I (K-Contact)	0.50	0.1	0.02	0.004

FPR 4-3316

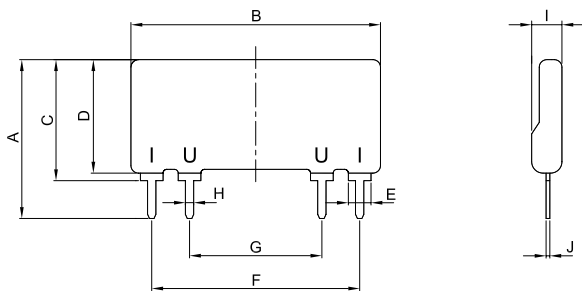

Dimension	mm	tol. (±mm)	inches	tol. (±inches)
A	21.00	0.2	0.83	0.008
B	33.00	0.2	1.30	0.008
C	16.00	0.2	0.63	0.008
D	15.00	0.2	0.59	0.008
E	3.00	0.1	0.12	0.004
F	27.50	0.2	1.08	0.008
G	17.50	0.2	0.69	0.008
H(A-Contact)	1.50	0.1	0.06	0.004
H(K-Contact)	1.10	0.1	0.04	0.004
I	4.30	0.2	0.17	0.008
J(A-Contact)	0.80	0.1	0.03	0.004
J(K-Contact)	0.50	0.1	0.02	0.004